

Applications of flow batteries in Africa



BUSHVELD
ENERGY

Presentation document

20 June 2018

www.bushveldenergy.com

Bushveld is an integrated vanadium-based platform which spans from extraction to manufacturing to deployment



- Integrated vanadium minerals company with an ~\$350m market capitalisation
- Operating the Vametco vanadium mine and processing plant in Brits, SA and producing more than 3% of world's vanadium
- Controlling multiple other large, open cast deposits with a 439.6Mt combined resource (including ~55 Mt combined reserves) in South Africa, host to the world's largest high-grade primary vanadium resources



- An energy storage solutions company, majority owned by Bushveld Minerals
- Exclusively focusing on vanadium redox flow battery technology with technical partner UniEnergy Technologies (UET) based in the USA
- Markets and develops projects using Vanadium Redox Flow Battery (VRFB) based energy solutions across Africa
- Working with the Industrial Development Corporation (IDC) to establish VRFB and electrolyte production in SA



Vanadium is the simplest and most developed flow battery

How does a vanadium redox flow battery (VRFB) work?

- A flow battery was first developed by NASA in the 1970s and is charged and discharged by a reversible reduction-oxidation reaction between the two liquid vanadium electrolytes of the battery
- Unlike conventional batteries, electrolytes are stored in separated storage tanks, not in the power cell of the battery
- During operation these electrolytes are pumped through a stack of power cells, or membrane, where an electrochemical reaction takes place and electricity is produced

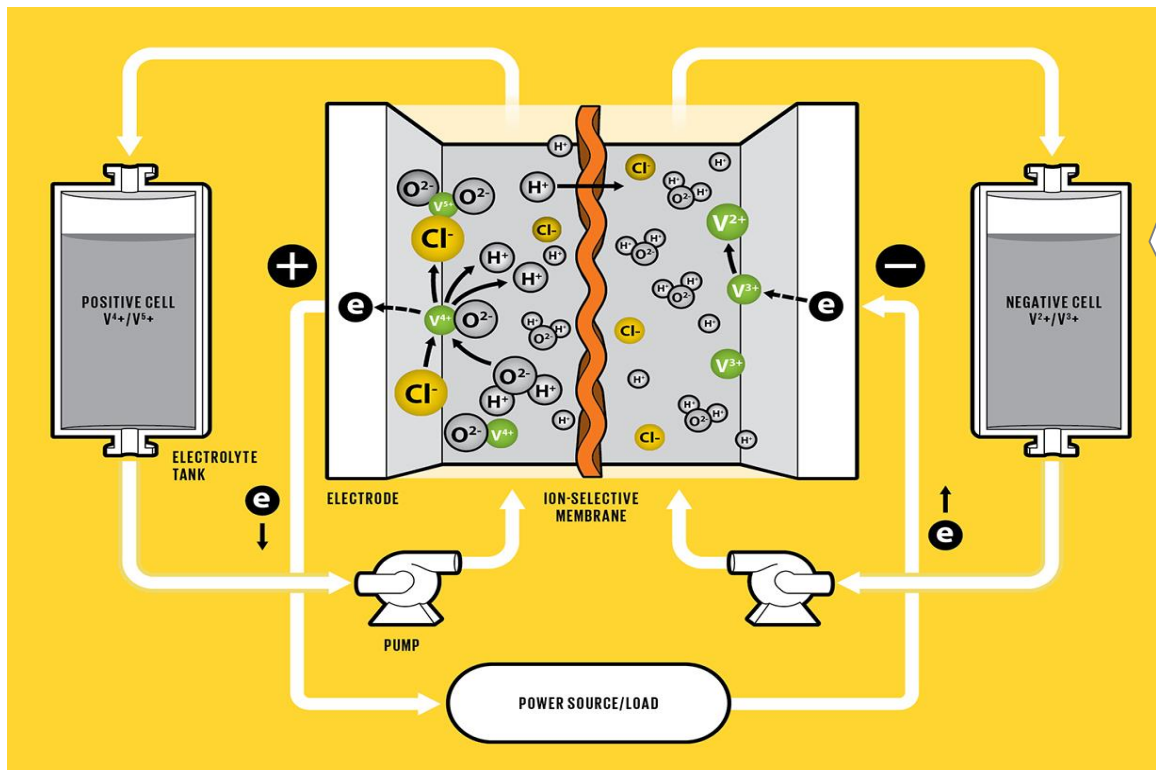

- Vanadium can exist in four different states, allowing for a single element to be used
- Benefits include simplicity and no cross-contamination
- In 2010, US DoE funded research at PNNL yielded an improved electrolyte formula

When used daily, VRFB technology has significant benefits, including being cheaper than lithium ion

VRFBs are ideal for large stationary applications

- + Long life and minimal reduction in performance during its life
 - + 100% depth of discharge
 - + Nearly unlimited number of cycles
- + Lowest cost per kWh when fully used once daily (or more frequently)
- + Easily scalable, as energy and power ratings are independent
- + Safety (no fire) and sustainability (100% of vanadium is reused at end of life)

VRFB is an excellent fit for daily, multi-hour, deep cycle storage (e.g. with solar PV), grid support (e.g. peak shaving, system balancing) and off-grid installations (e.g. mines, farms, islands)

Investment bank Lazard analysis shows that VRFBs already have the lowest costs in the industry

USD / kWh,¹ 2017, levelised costs ■ Lithium-Ion ■ VRFB

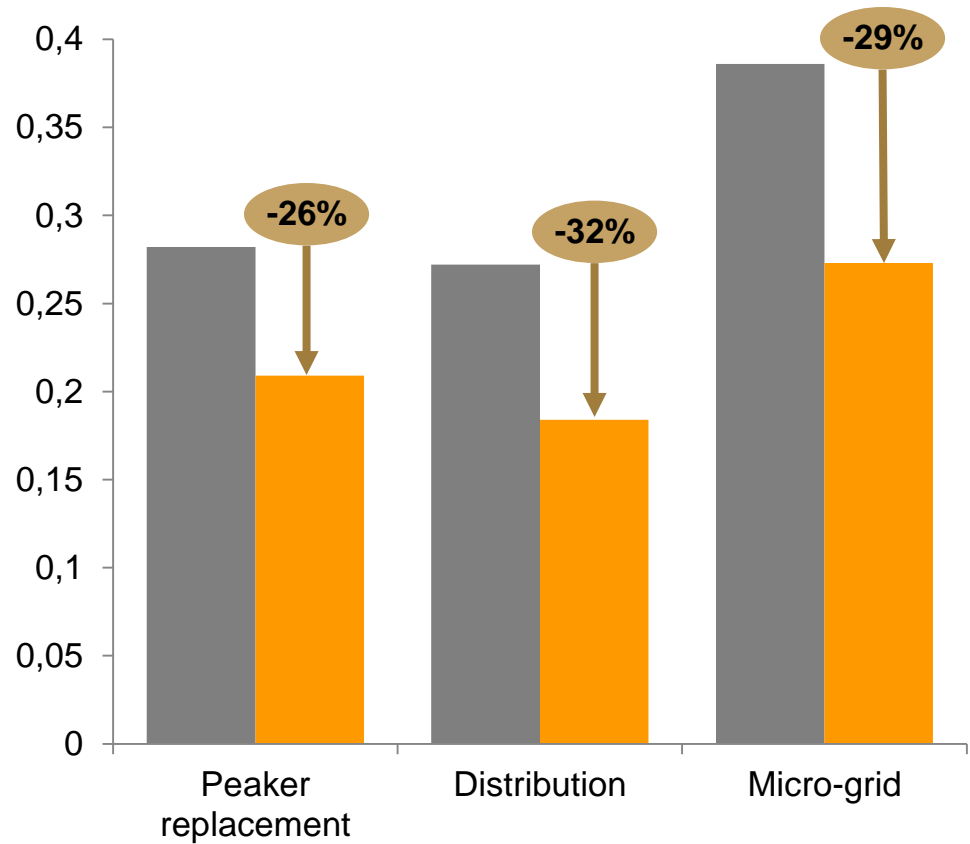

LAZARD

VRFBs are technically and commercially attractive in many but not all applications

- VRFB applications
- ⊗ Detailed further

Selected storage applications based on daily usage and storage requirements

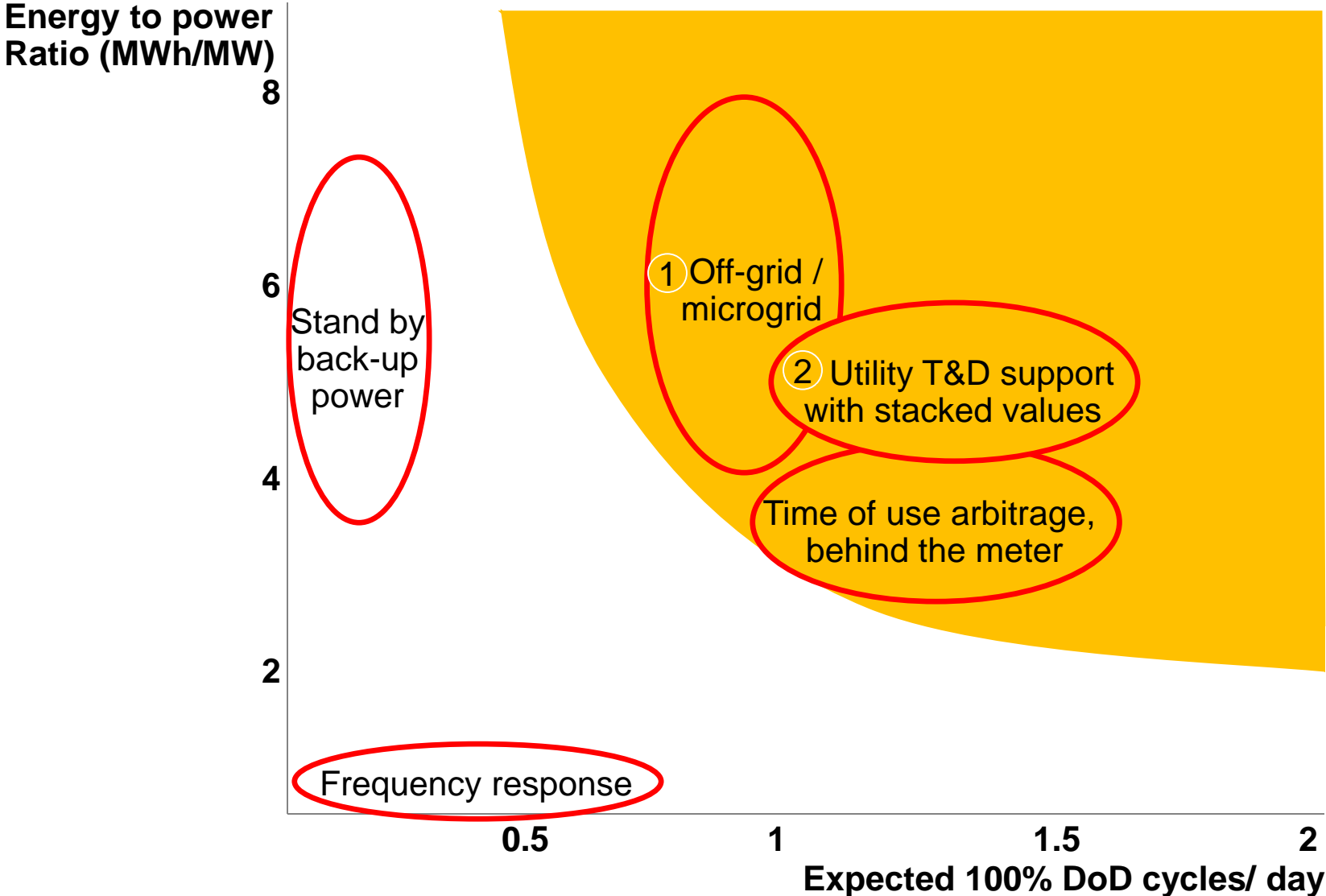

SOURCE: Bushveld Energy

Especially in Asia, VRFBs are used in large scale energy storage projects

I. 60 MWh VRFB from Sumitomo in Hokkaido, Japan



Transmission Line
 Power Plant — 275kV
 Substation — 187kV
 — 110kV

Minami-Hayakita S/S

HEPCO PJ (online @Dec.,2015)
 Size : **15 MW / 60 MWh**
 (max. capacity: 30 MW)
 Application: Multi-purpose
 - Renewable generation mitigation
 - Frequency control, etc
 Funded by Japanese government

2nd Fl.: Battery cubicles

1st Fl.: Electrolyte tanks & PCS

SUMITOMO ELECTRIC GROUP

II. 800 MWh VRFB by Rongke Power in Dalian, China

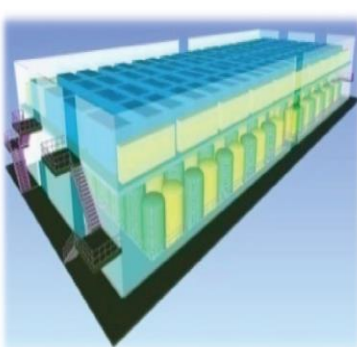

Specification:
 Rated power: 200MW
 Rated capacity: 800MWh
 AC Efficiency: >70%

Components:
 Battery: 500kW/2MWh×400
 PCS: 550kVA×400
 Transformer: 2500kVA×100
 EMS: 1 unit
 SCADA: 1 unit

Location: Dalian City, CHINA

The first floor : Electrolyte tank
 The second floor: Power unit + control unit
 The third floor: PCS + Transformer

RONGKE POWER

III. 400 MWh VRFB from Pu Neng in Hubei, China



- 3-phase project to be finished by 2020
- Cornerstone of a new smart energy grid in Hubei Province.
- Will serve as a critical peaker plant, deliver reliability and reduce emissions

PU NENG
 THE FUTURE OF ENERGY STORAGE



Containerised solutions are ideal for installations in the 500kWh to 50MWh sizes, as per Bushveld's current project with Eskom



Our focus is on containerised VRFB technology in utility scale applications

1MW/4MWh UET system with Avista in Pullman, WA, USA



- Containerised, “plug & play” design
- Located on the edge of building parking lot, with a 14x18m footprint
- Connected to the grid or the customer’s power supply through a transformer



**1 Given the great solar radiation, Africa is an excellent fit for PV+VRFB
“true hybrid” microgrids**

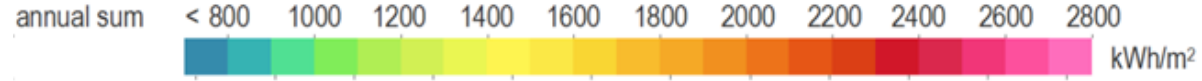

Africa has the world's best solar radiation

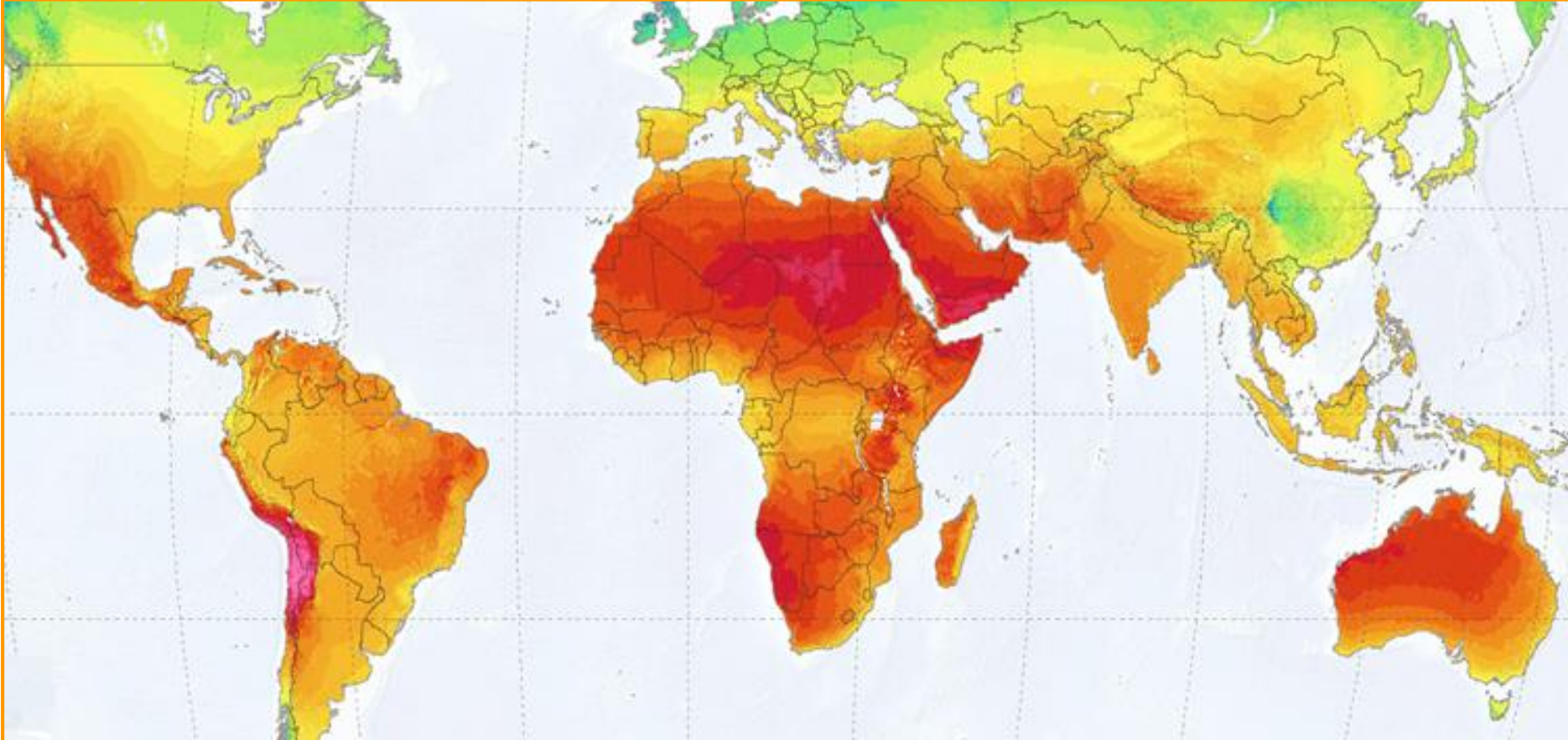

As a result, Africa is an ideal fit for solar + storage true hybrid solutions

1 An example of one such “pure hybrid” project: Technical design for an off-grid PV+VRFB system & existing 250kVa genset

Single Line Diagram of proposed technical configuration

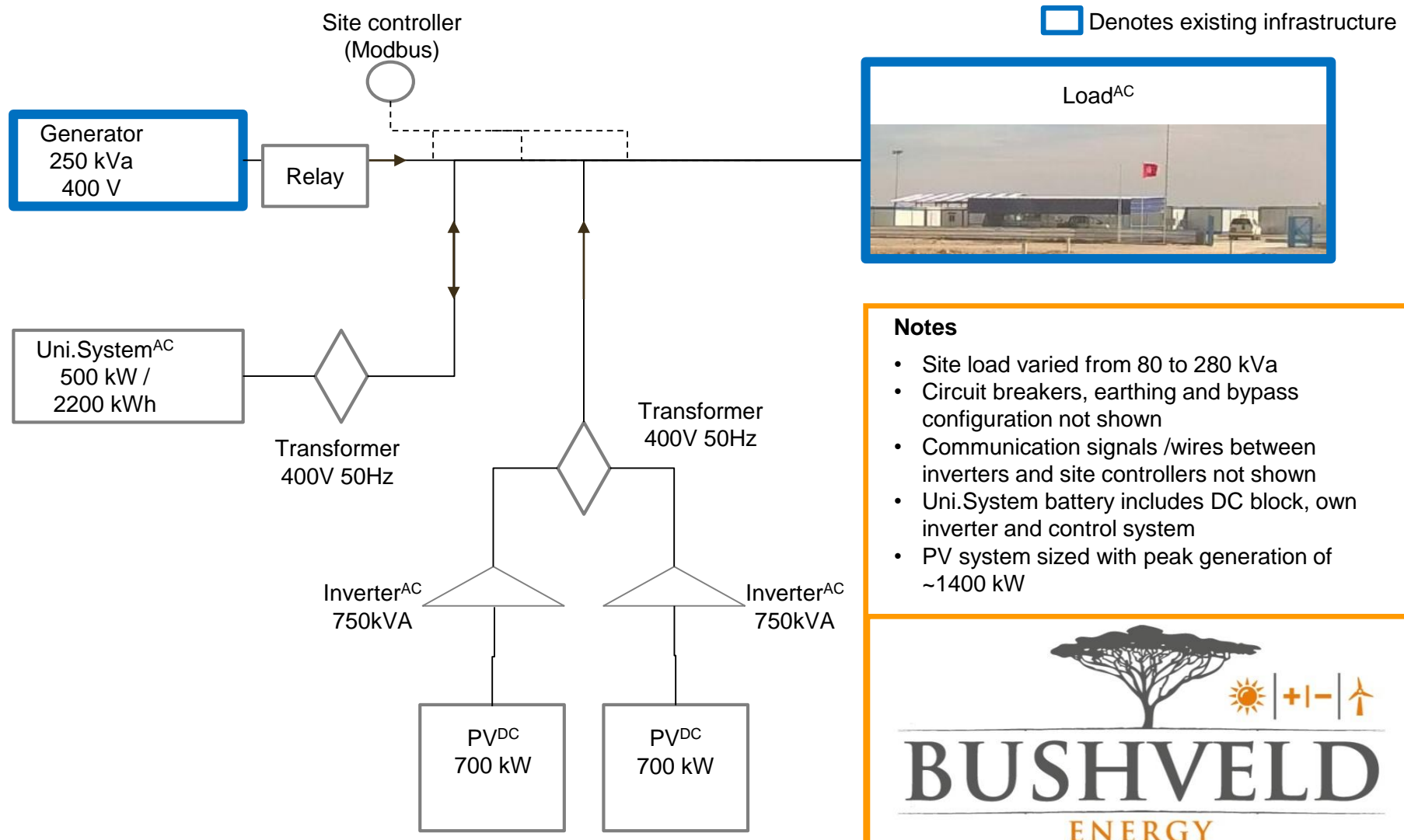

- Notes**
- Site load varied from 80 to 280 kVa
 - Circuit breakers, earthing and bypass configuration not shown
 - Communication signals /wires between inverters and site controllers not shown
 - Uni.System battery includes DC block, own inverter and control system
 - PV system sized with peak generation of ~1400 kW



1. This is the energy balance for a typical day for such a 1.4MW PV (no tracker), 0.5MW/2.2MWh system

Day time generation and customer load profile

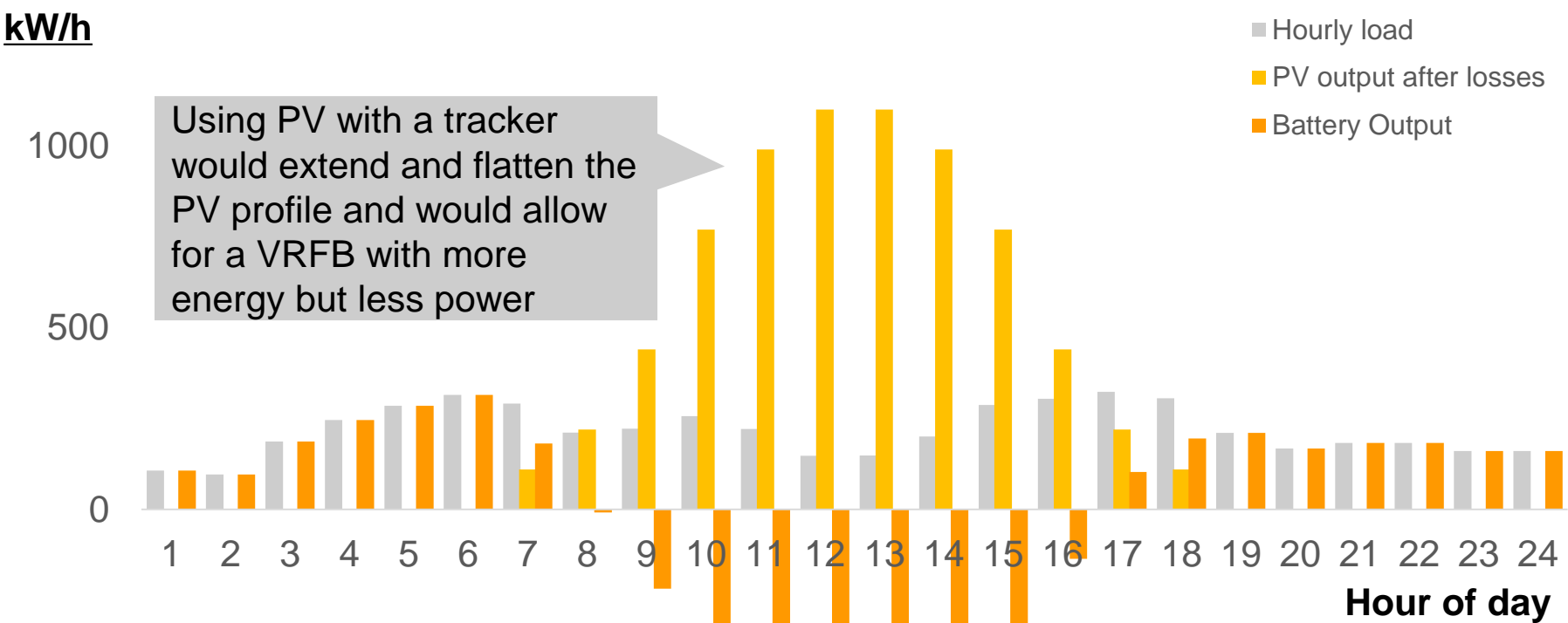

1. Weather and the desire to reduce diesel consumption impact system sizing significantly

Even in a desert climate, seasonality in weather, led us to offer the customer three design options, based on cost and supply guarantee

Option	PV System	Energy Storage System	System Availability (Excl. Rainy days)	System Availability (Incl. Rainy days)
1	1 280kWp	500kW / 2 200kWh	83%	76%
2	1 434kWp	625kW / 2 750kWh	92%	85%
3	1 532kWp	750kW / 3 300kWh	99%	92%

- **A 100% renewable energy solution prohibitively expensive** (as the additional PV and storage capacity would only be used a few days each year)
- **Option 1 offered the lowest cost per energy** (energy produced by adding capacity of both PV and VRFB from Option 1 to Options 2 or 3 exceeded the cost of diesel generation for that same energy)
- **Options 2 and 3 are only relevant if customer is willing to pay a premium** for less diesel supply (e.g. emission reduction)
- While the load profile impacted the ratio of PV to storage, **seasonality significantly impacted the sizing** of both compared to the diesel

2. Battery storage in particular offers many confirmed benefits for a power system, as well as individual customers

Utility scale energy storage use cases and their relevant time scales

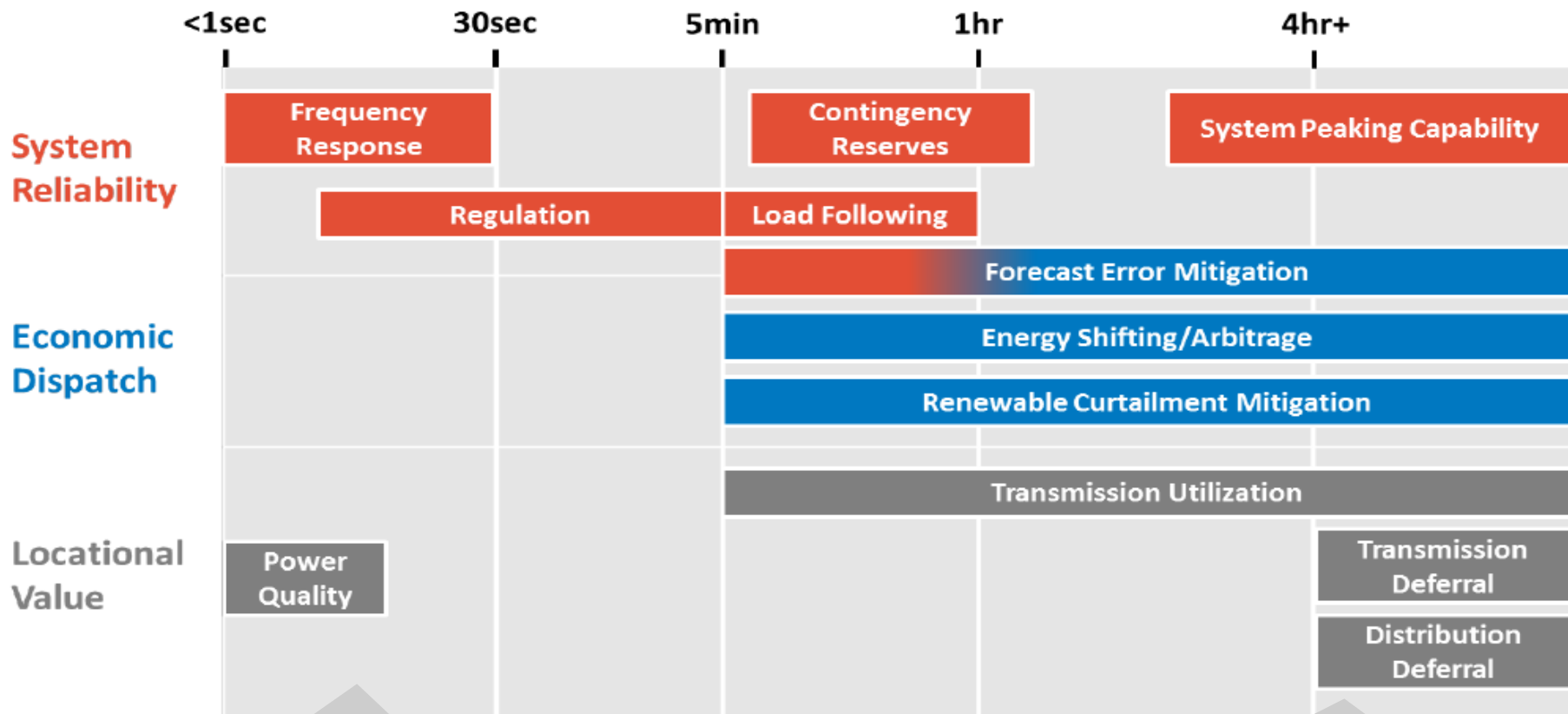

Can only be provided by distributed storage technologies, usually of 1-10MW size

- Other benefits such as
- Technical loss reduction
 - Time shifting of losses
 - System resiliency
 - Customer UPS

2. The challenge with utility application is monetising and calculating (or stacking) all the possible value streams

For multi-value stream sites, value “stacking” is the approach to quantify total value

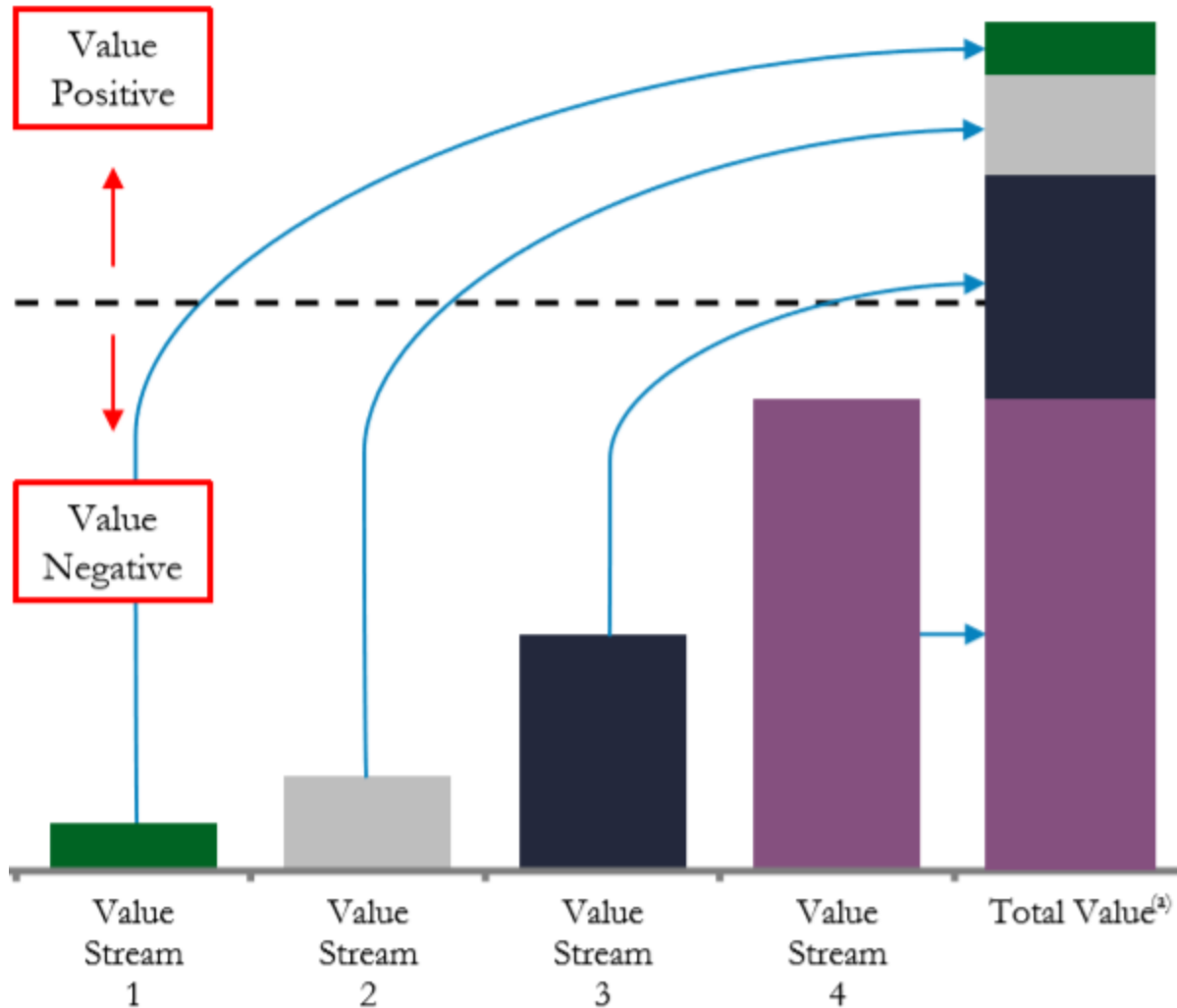

Although simple in theory, actual stacking requires significant analysis of questions such as:

- How many of the values can one system perform?
- To what degree can each value be captured (e.g. 50%, 80%)?
- How will multiple implications impact the battery's cost (e.g. inverter, software) and lifetime (e.g. cycles, stage of charge)?
- How to value future cost increases?

2. Calculating and evaluating these value and how the VRFB can perform them all is a major component of our current project with Eskom

Context to project

- Peak 120kW/450kWh VRFB located at Eskom's Research & Technology micro-grid site
- Project development by Bushveld Energy and IDC
- Integration performed by Bushveld Energy, with VRFB from UniEnergy Technologies
- Eskom's operational objectives for the VRFB:
 - Minimum load shifting;
 - Wind smoothing;
 - Solar smoothing;
 - Improved power quality;
 - Micro-grid black-start;
 - A combination of the above (including cannibalisation);
 - Other applications, as to be determined.

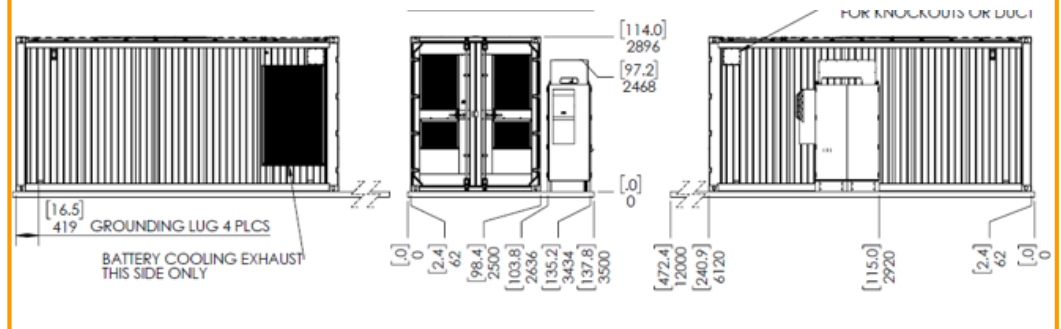

Thank you for your attention

Contact details:

www.bushveldenergy.com

info@bushveldenergy.com

+27 11 268 6555